

Article number: 20288B25B30T2BL

Description: E+G Swivel clamp - GN 288-B25-B30-T-2-BL

## Measures

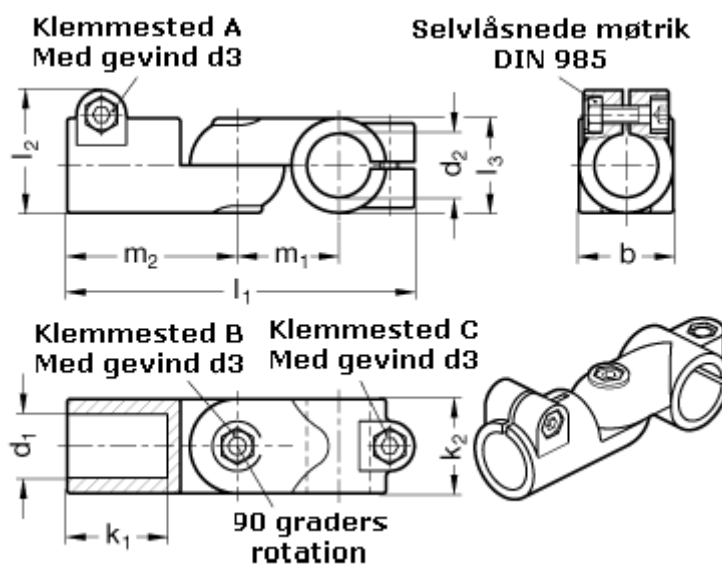

$b = 40$

$d_1 = B25$

$d_2 = B30$

$d_3 = M 8$

$k_1 = 42.5$

$k_2 = 40$

$l_1 = 147$

$l_2 = 52.0$

$m_1 = 43$

$m_2 = 72$